

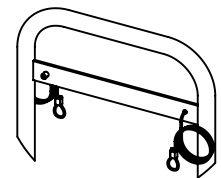

TRILARY, INC.  
 1080 UNIEK DRIVE  
 WAUNAKEE, WI 53597  
 P(800) 448-7931, P(608) 849-1080, F(608) 849-1081  
 WWW.MADRAX.COM, E-MAIL: SALES@MADRAX.COM

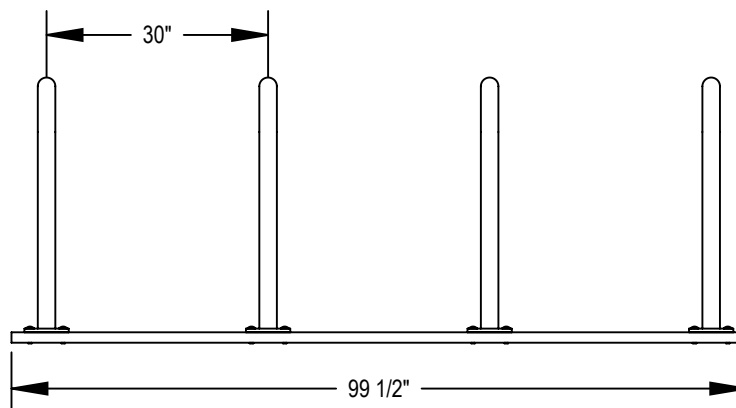
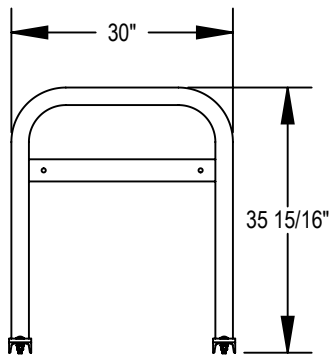
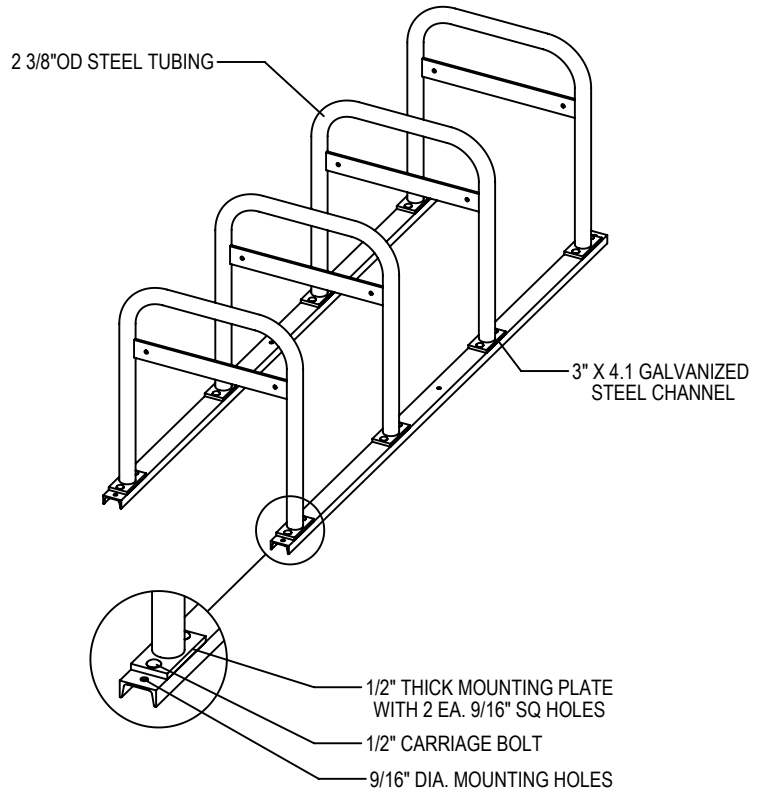
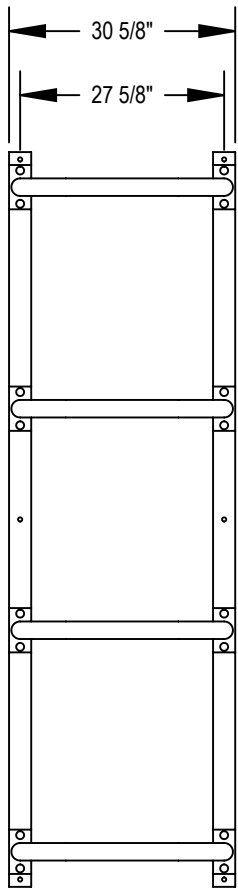

OPTIONAL LOCKING CABLES (UX238-LBC-8)

PRODUCT: UX238-LB(C)-8  
 DESCRIPTION: UX238-LB 'U' ON RAIL BIKE RACK WITH LEAN BAR  
 8 BIKE, 4 LOOP, SURFACE  
 DATE: 2-22-07  
 ENG: TLG

CONFIDENTIAL DRAWING AND INFORMATION IS NOT TO BE COPIED OR DISCLOSED TO OTHERS WITHOUT THE CONSENT OF TRILARY, INC. SPECIFICATIONS ARE SUBJECT TO CHANGE WITHOUT NOTICE.

©2007 TRILARY, INC. ALL PROPRIETARY RIGHTS RESERVED.

NOTES:

1. INSTALL BIKE RACKS ACCORDING TO MANUFACTURER'S SPECIFICATIONS.
2. CONSULTANT TO SELECT COLOR(FINISH), SEE MANUFACTURER'S SPECIFICATIONS.
3. SEE SITE PLAN FOR LOCATION OR CONSULT OWNER.