

HOOK HOLDS BIKE
FOR LOADING

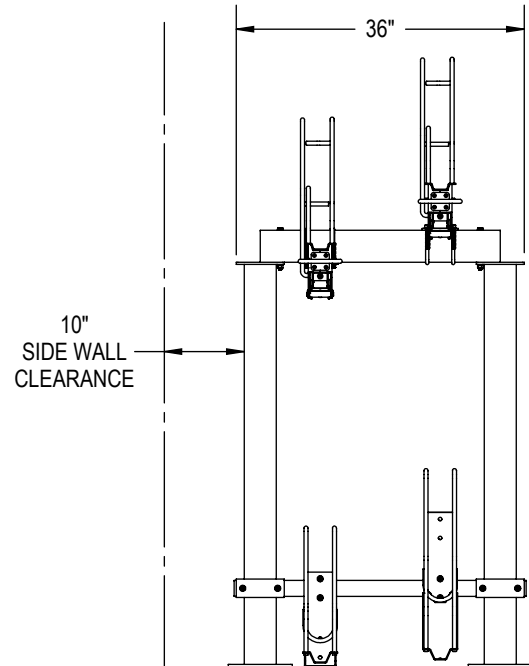
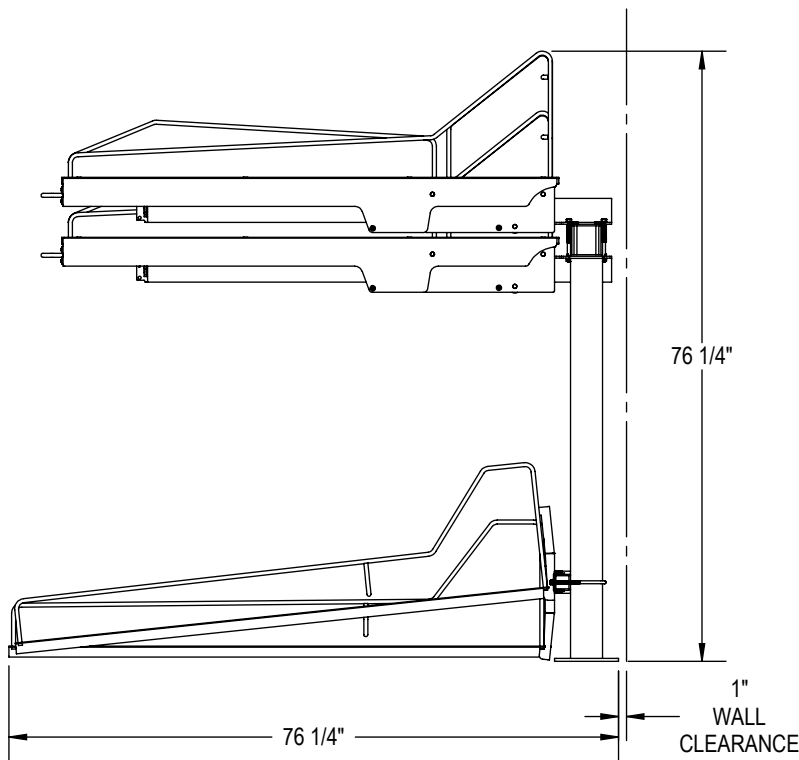
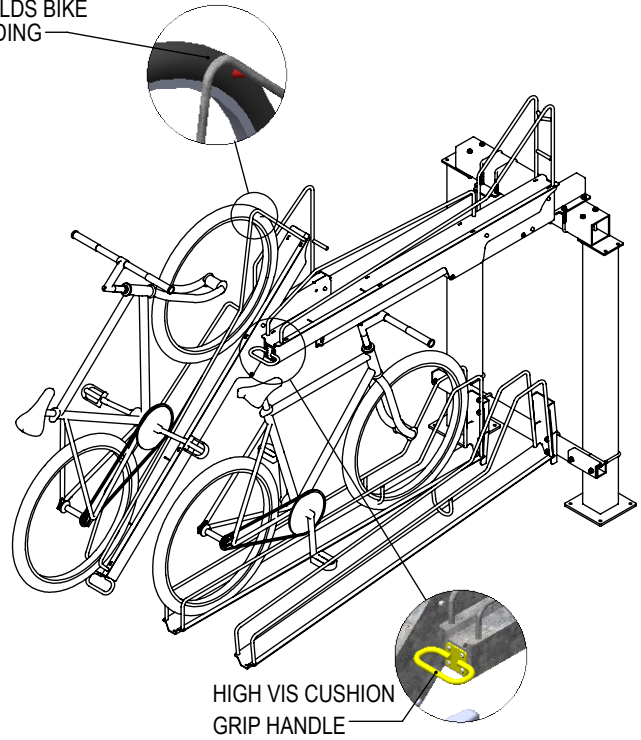

PRODUCT: BBS-SNG-4
DESCRIPTION: BOOST BIKE STORAGE, 4 BIKE CAPACITY

DATE: 8-31-2017
ENG: BLW

CONFIDENTIAL DRAWING AND INFORMATION IS NOT TO BE COPIED OR DISCLOSED TO OTHERS WITHOUT THE CONSENT OF GRABER MANUFACTURING, INC. SPECIFICATIONS ARE SUBJECT TO CHANGE WITHOUT NOTICE.

- THE FINISH IS HOT DIP GALVANIZE FOR CORROSION PROTECTION
- HANDLE IS COATED FOR VISIBILITY AND PROTECTION
- RED FRONT WHEEL HOOK HOLDS THE BIKE FOR LOADING AND KEEPS IT SECURE.

NOTES:

1. INSTALL BIKE RACKS ACCORDING TO MANUFACTURER'S SPECIFICATIONS.
2. CONSULTANT TO SELECT COLOR (FINISH), SEE MANUFACTURER'S SPECIFICATIONS.
3. SEE SITE PLAN FOR LOCATION OR CONSULT OWNER.