

SHOWN WITH TOP REMOVED

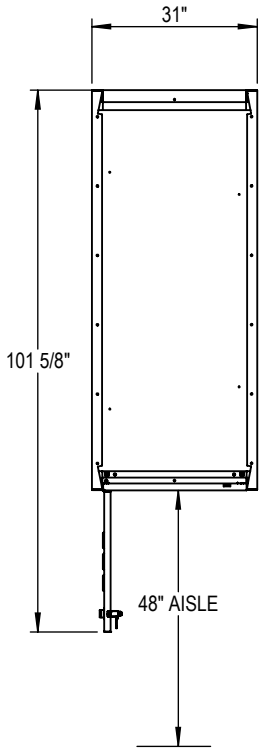

ALLOW FOR LOADING OF BIKE.
SUGGESTED CLEARANCE OF 60"
(MINIMUM OF 48").

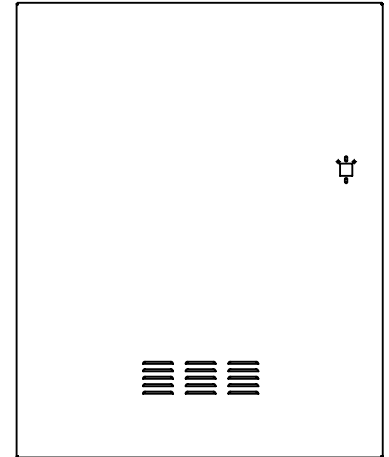
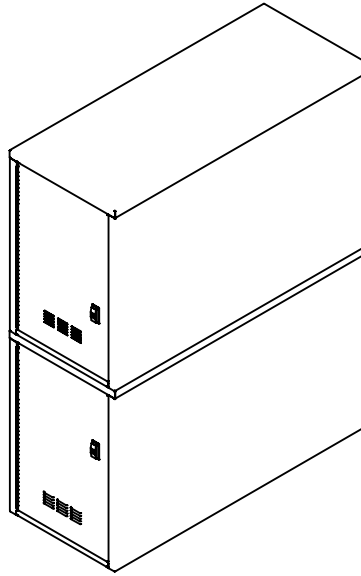

SOLID DOOR

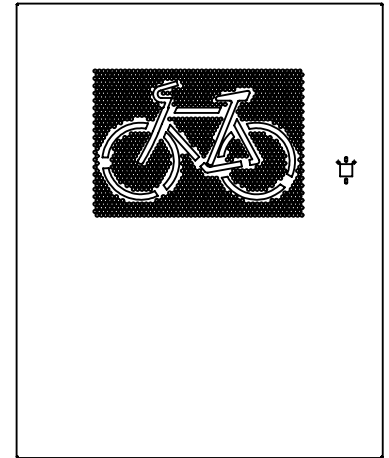

BICYCLE PERFORATION DOOR

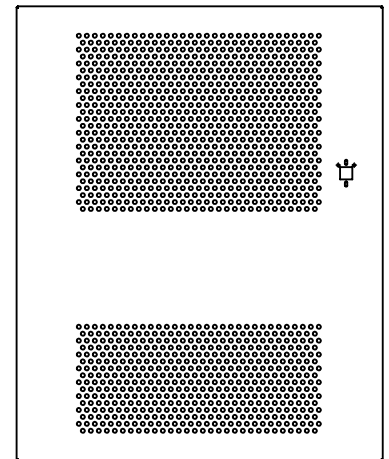

FULL PERFORATION DOOR

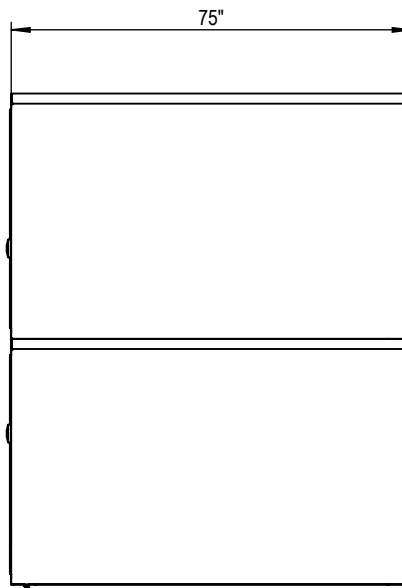
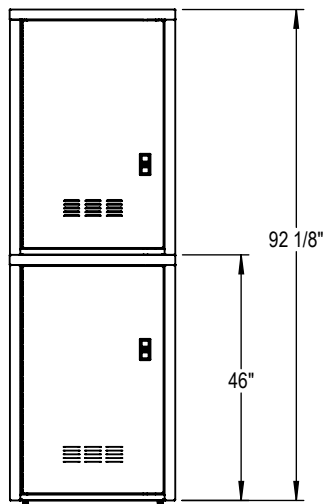

CHECK LOCKING STYLE

- HEAVY DUTY 4266 POP-OUT "T" HANDLE WITH 2 USER KEYS (KEYED DIFFERENTLY)
- STEEL U-LOCK AND PADLOCK STYLE HANDLE (PADLOCK AND U-LOCK NOT INCLUDED)

OTHER AVAILABLE OPTIONS:

- NUMBER PLATES
- GRAFFITI RESISTANT ADDITIONAL COATING

PRODUCT: MLN-1 AND MLNT-1
DESCRIPTION: MADLOCK™ NARROW BIKE LOCKER
2 UNITS STACKED - 2 DOOR, 2 BIKE CAPACITY
DATE: 10-10-18
ENG: SMC

NOTES:

1. INSTALL BIKE RACKS ACCORDING TO MANUFACTURER'S SPECIFICATIONS.
2. CONSULTANT TO SELECT COLOR (FINISH), SEE MANUFACTURER'S SPECIFICATIONS.
3. SEE SITE PLAN FOR LOCATION OR CONSULT OWNER.