

RECYCLED PLASTIC
OR IPE WOOD

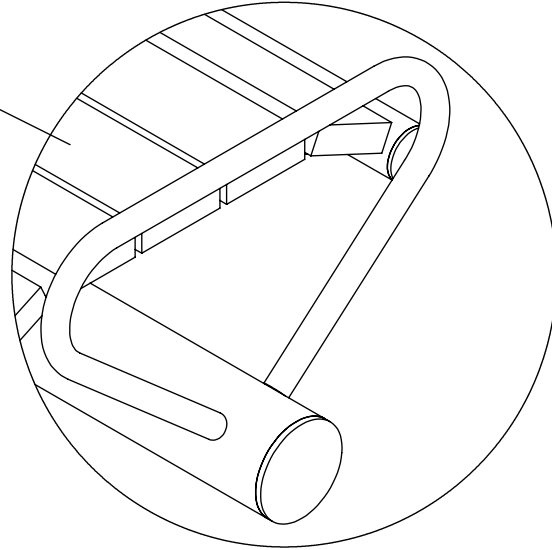

3/4" ROUND STEEL ROD

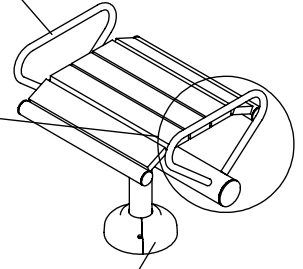

DIE CAST GROUT COVERS

ARM OPTION - SPECIFY
NUMBER OF ARMS DESIRED _____

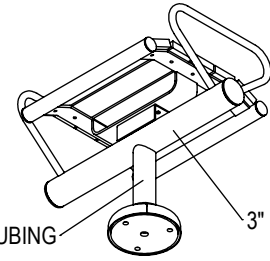
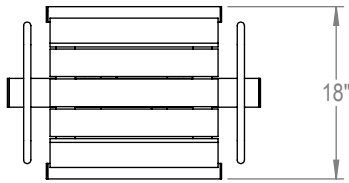

2 3/8" DIAMETER TUBING

3" DIAMETER TUBING

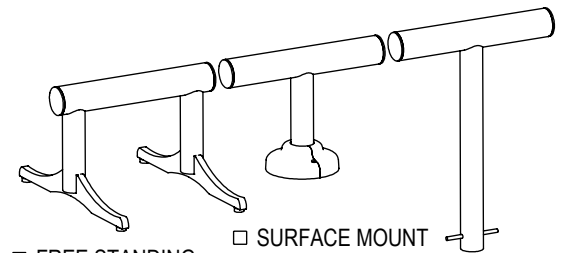
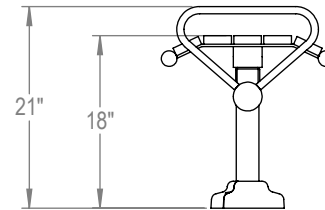
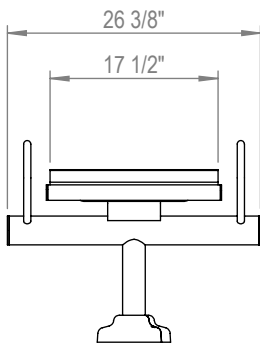

FREE STANDING

SURFACE MOUNT

IN GROUND

CHECK DESIRED MOUNT

ALL FASTENERS ARE STAINLESS STEEL
SOME ASSEMBLY REQUIRED

PRODUCT: GRMF-1
DESCRIPTION: GRAMERCY FLAT MODULAR BENCH,
1 SEAT

DATE: 6-14-16
ENG: SMC

CONFIDENTIAL DRAWING AND INFORMATION IS NOT TO BE COPIED OR DISCLOSED
TO OTHERS WITHOUT THE CONSENT OF GRABER MANUFACTURING, INC.
SPECIFICATIONS ARE SUBJECT TO CHANGE WITHOUT NOTICE.

SITE FURNISHING IS POWDER COATED WITH TGIC POLYESTER.
STEEL SURFACE PREP INCLUDES MECHANICAL AND CHEMICAL
ETCHING FOLLOWED WITH A COATING TO IMPROVE ADHESION
AND CORROSION RESISTANCE.