

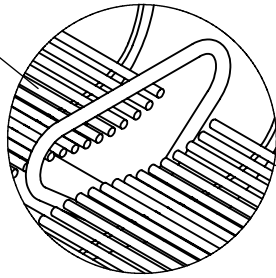

Ø 1/2" STEEL ROD



3/4" ROUND STEEL ROD

ARM OPTION - SPECIFY  
NUMBER OF ARMS DESIRED \_\_\_\_\_

DIE CAST GROUT COVERS

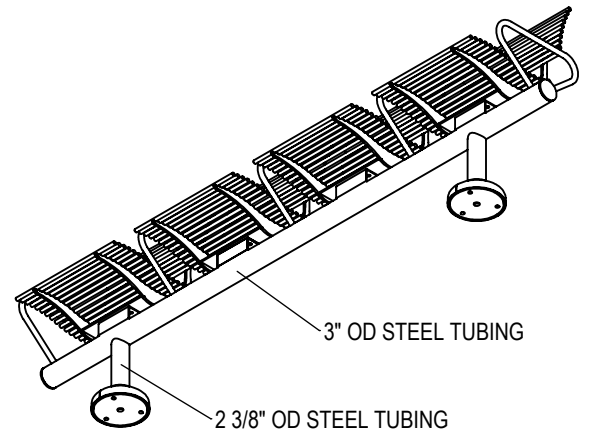
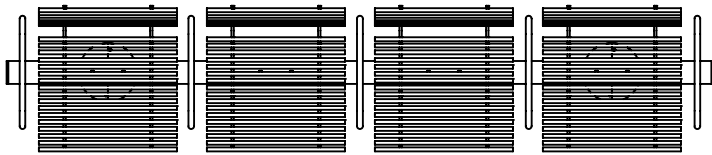
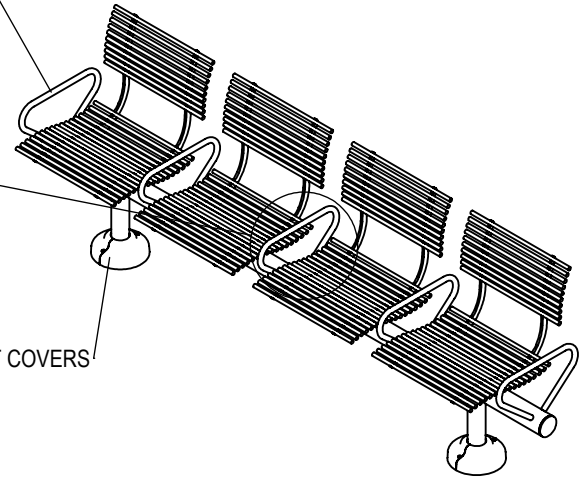

3" OD STEEL TUBING

2 3/8" OD STEEL TUBING

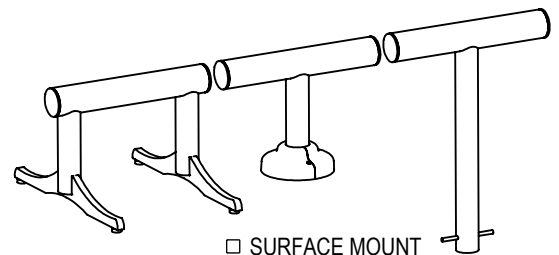
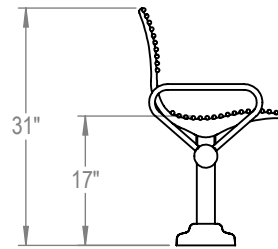
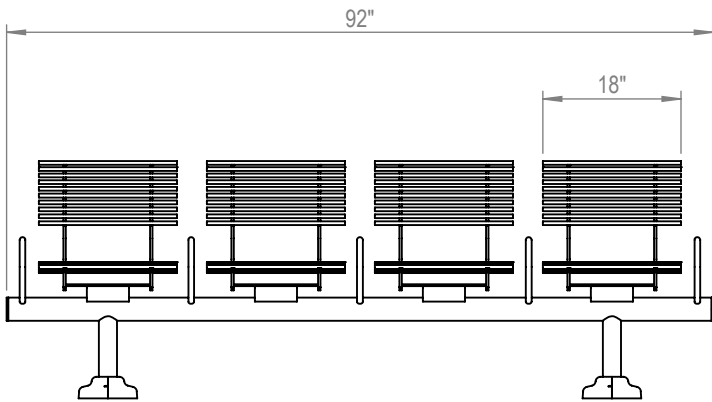

FREE STANDING

SURFACE MOUNT

IN GROUND

CHECK DESIRED MOUNT

PRODUCT: VLMB-4  
DESCRIPTION: VOLARE BACKED MODULAR BENCH,  
4 SEAT

DATE: 6-15-16  
ENG: SMC

ALL FASTENERS ARE STAINLESS STEEL  
SOME ASSEMBLY REQUIRED

CONFIDENTIAL DRAWING AND INFORMATION IS NOT TO BE COPIED OR DISCLOSED  
TO OTHERS WITHOUT THE CONSENT OF GRABER MANUFACTURING, INC.  
SPECIFICATIONS ARE SUBJECT TO CHANGE WITHOUT NOTICE.

SITE FURNISHING IS POWDER COATED WITH TGIC POLYESTER.  
STEEL SURFACE PREP INCLUDES MECHANICAL AND CHEMICAL  
ETCHING FOLLOWED WITH A COATING TO IMPROVE ADHESION  
AND CORROSION RESISTANCE.